

benling

80CC 技术规格书及使用手册

80CC SPECIFICATION

上海本菱涡旋压缩机有限公司·研发中心

SHANGHAI BENLING SCROLL COMPRESSOR CO., TECHNOLOGY CENTER

注意事项

请在操作使用前，首先仔细阅读下述内容

在本文未尽说明时，欢迎访问 BENLING 官方网站：www.benling-sh.com 以获得更详尽内容，或者垂询 021-57483303 获取资讯。

Please read the following carefully before using

If not covered in this article, please visit the BENLING website: www.benling-sh.com for more details, or contact 021-57483303.

安全与法规 Safety and regulations



警告 Warning

为避免因触电、短路、损伤、火灾或其他危险可能导致的严重受伤甚至死亡，请务必遵守下列基本注意事项。这些注意事项包括但不限于下列情况：

To avoid serious injury or death due to electric shock, short circuit, damage, fire, or other hazards, follow the following basic precautions. These considerations include, but are not limited to, the following:

请勿打开 Do not disassemble

● 本产品不含任何用户可自行修理的零件。请勿打开本产品或试图拆卸其内部零件或进行任何方式的改造。若出现异常，请立即停止使用，并资讯有 BENLING 资质认可的维修人员。

● 对于不正当使用或擅自改造本产品所造成的损失、人身伤害、意外等，BENLING 不负任何责任。

● This product does not contain any parts that can be repaired by the user. Do not open this product or attempt to disassemble its internal parts or alter it in any way. If anything abnormal occurs, please stop use immediately and contact a BENLING qualified maintenance personnel.

● BENLING shall not be liable for any loss, personal injury or accident caused by improper use or unauthorized modification of this product.

电气安全 Electrical safety

● 供电侧前端请设置预充电电路。

● 高低压电源的极性不可反接，否则有损坏压缩机的可能性。

● 请在压缩机的工作范围内使用，以保证压缩机的正常工作。

压缩机使用安全 Compressor safety in use

● 搬运时请双手托举压缩机，请勿用手拉扯线束。

● 压缩机内充注有干燥的氮气，在拔除压缩机的管塞时压缩机应处于水平位置，先拔出排气管塞，后拔出吸气管塞，以防止冷冻机油喷出，并建议尽快完成吸排气管的安装并开始抽真空。

● 压缩机内充注有干燥的氮气，在拔除压缩机的管塞时压缩机应处于水平位置，先拔出排气管塞，后拔出吸气管塞，以防止冷冻机油喷出，并建议尽快完成吸排气管的安装并开始抽真空。

● 加注制冷剂前，系统进行抽真空处理，真空度达到-0.095MPa 下保持 5 分钟后再加注制冷剂，加注时请从压缩机的排气管加注。

● 新的压缩机内已有冷冻机油，不需要补加，不建议更换压缩机的冷冻机油的种类，且不建议不同品牌的冷冻机油混合使用。

● 安装管路时请保持清洁，避免异物进入管路。

● 禁止压缩机不加注制冷剂的情况下连续空载运行，否则会损坏压缩机。

● 压缩机安装任意方向倾斜角建议不大于 10° 。

● Please set the pre-charging circuit at the front end of the power supply side.

● The polarity of the high and low voltage power supply cannot be reversed, otherwise there is the possibility of damaging the compressor.

- Please use within the working range of the compressor to ensure the normal operation of the compressor.

- When handling, please lift the compressor with both hands. Do not pull the wire harness with your hands.

- The compressor is filled with dry nitrogen. When removing the tube plug of the compressor, the compressor should be in a horizontal position. The exhaust pipe plug should be pulled out first, and then the suction pipe plug should be pulled out to prevent the ejector of refrigerant oil.

- The compressor is filled with dry nitrogen. When removing the tube plug of the compressor, the compressor should be in a horizontal position. The exhaust pipe plug should be pulled out first, and then the suction pipe plug should be pulled out to prevent the ejector of refrigerant oil.

- Before filling refrigerant, the system should carry out vacuum treatment, and keep the vacuum at -0.095MPa for 5 minutes before filling refrigerant. Please fill refrigerant from the exhaust pipe of the compressor when filling.

- There is already refrigerated oil in the new compressor, which does not need to be supplemented. It is not recommended to change the type of refrigerated oil in the compressor, and it is not recommended to mix different brands of refrigerated oil.

- When installing the pipeline, keep it clean to avoid foreign matter entering the pipeline.

- It is forbidden to run continuously without refrigerant in the compressor, otherwise the compressor will be damaged.

- The inclination Angle of the compressor in any direction is not more than 10° .



ROHS



目录 Catalog

1. 适用范围及标准 Application and standard.....	1
2. 技术参数 Technical Parameters.....	3
2.1 压缩机基本参数 Compressor basic parameters.....	3
2.2 电性能 Electrical Performance.....	4
2.3 驱动器信息 PCB Information.....	5
2.4 接插件 Connector.....	5
2.5 制冷性能 Cooling Capacity.....	7
2.6 噪声 Noise.....	9
3. 使用要求 Requirement.....	10
3.1 系统建议 System recommendations.....	10
3.2 压缩机推荐运行范围 Recommended working condition.....	12
4. 附件 A Annex A.....	13
80 系列产品对比 80 series product comparison.....	13

1. 适用范围及标准 Application and standard

本技术规格书适用于本菱 80CC A0~A9 系列 压缩机。

This specification is applied for BENLING 80CC A0~A9 compressor.

标准依据 Standard:

CB/T 22068-2018	汽车空调用电动压缩机总成 Electric compressor assembly for automotive air conditioning
GB/T 2423. 17	电工电子产品环境试验 第 2 部分:试验方法 试验 Ka:盐雾 Environmental testing for electrical and electronic products - Part 2: Test methods - Test Ka: salt spray
GB/T 2423. 22-2002	环境试验 第 2 部分:试验方法试验 N:温度变化 Environmental tests - Part 2: Test methods - Test N: Temperature change
GB/T 2423. 34-2005	环境试验 第 2 部分:试验方法试验 Z/AD:温度/湿度组合循环试验 Environmental tests-Part 2: Test methods Test Z/AD: Combined temperature/humidity cycle test
GB/T4208-1993	外壳防护等级(IP 代码) Enclosure protection Class (IP code)
GB/T17619-1998	机动车电子电器组件的电磁辐射抗扰性限值和测量方法 Electromagnetic radiation immunity limits and measurement methods for motor vehicle electronic and electrical components
GB/T18488. 1-2006	电动汽车用驱动电机系统 第 1 部分:技术条件 Drive motor systems for electric vehicles - Part 1: Technical requirements
GB/T18655-2002	车辆、船和内燃机 无线电骚扰特性用于保护车载接收机的限值和测量方法 Vehicle, ship and internal combustion engine radio disturbance characteristics Limits and measurement methods used to protect on-board receivers
GB/T19951-2005	道路车辆-静电放电产生的电骚扰试验方法 Road vehicles - Test method for electrical disturbance caused by electrostatic discharge

JB/T9617-1999	<p>直流电机电枢绕组匝间绝缘试验规范 Test specification for inter-turn insulation of DC motor armature winding</p>
QC/T413-2002	<p>汽车电气设备基本技术条件 Basic technical conditions of automotive electrical equipment</p>
QC/T660-2000	<p>汽车空调(HFC-134a)用压缩机试验方法 Test method for compressors for automotive air conditioning (HFC-134a)</p>
IS07637-2:2004	<p>道路车辆. 电导和耦合引起的电干扰第 2 部分: 标称电源电压 24v 的商用车辆. 仅沿电源线的瞬间电导 Road vehicles - Electrical disturbances due to conductance and coupling - Part 2: Commercial vehicles with a nominal supply voltage of 24 V. Instantaneous conductance only along the power line</p>
IS07637-3:2007	<p>道路车辆. 传导和耦合引起的电干扰第 3 部分: 通过电容合和合经源线线路的瞬间电传输 Road vehicles - Electrical interference due to conduction and coupling - Part 3: Transient electrical transmission via capacitors and via source lines</p>

2. 技术参数 Technical Parameters

2.1 压缩机基本参数 Compressor basic parameters

压缩机方式 Compressor style	全封闭卧式涡旋压缩机 Hermetic horizontal scroll compressor
可使用冷媒 Refrigerant	R134a/HF01234-yf
排气容积 Displacement	80cm ³ /rev
常用转速范围 Normal speed	3000-6000rpm
额定电压最高转速 Max. speed at rated voltage	6000rpm
蒸发温度范围 Evaporating normal temperature	-25-20°C
冷凝温度范围 Condensing temperature	+30-65°C
压缩机冷却方式 Compressor cooling method	吸气冷却 Suction cooling
制冷剂泄漏量 Refrigerant leakage rate	≤14g/y
冷冻油/油量 Refrigeration oil	POE68 800CC (系统适配由客户自行标定) (System adaption is calibrated by the customer)
外观 Appearance	铸铝表面喷砂 Cast aluminum surface sandblasted
总质量 Total weight	17.5kg
外形尺寸 Dimensions	见附件 A: 《80 系列产品对比》 See Annex A: Comparison of 80 Series Products
吸气管接口内径 Suction port inner size	25mm
排气管接口内径 Exhaust port inner size	18.3mm

2.2 电性能 Electrical Performance

压缩机分类及描述 Compressor classification and description

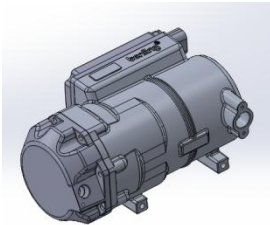
压缩机分类 Compressor classification	描述 Description	示意图 Schematic Diagram
I 类 Class I	固定式 Fixed	

型号 Model	A3	C3	
	I 型 Class I		
额定电压 (V) Rated Voltage	540		
电压范围 (V) Voltage Range	400-750		
最大转速 (RPM) Maximum speed	6000		
过压恢复值 (V) Over-voltage Recovery	730		
欠压恢复值 (V) Under-voltage Recovery	420		
最大输入电流 (A) Maximum Input Current	26.48		
最大输入功率 (KW) Maximum Input Power	14.3		
输入功率 (KW) Input Power	9.66		
电机类型 Motor Type	永磁无刷直流电机 Permanent Magnet Brushless DC Motor		
定子绕组接法 Stator Winding Connection	三相 Y 形 Three-phase Y connection		
绝缘特性 IR standard	$\geq 10M\Omega$ (GBT22068-2018)		
耐电压 Withstand Voltage	额定电压=540V Rated voltage =540V	试验电压 2080V Test voltage 2080V	$\leq 20mA$

2.3 驱动器信息 PCB Information

电机控制方式 Motor control Method	正弦波驱动方式 Sine wave drive mode	
磁极位置检测方式 Magnetic pole position detection method	无位置传感器 Unposition sensor	
控制器低压电源额定电压 (V) PCB Low Voltage power supply rated voltage (V)	12	24
控制器低压电源电压范围 (V) PCB Low Voltage power supply voltage range (V)	9-16	16-31
防护等级 IP RATE	IP67	
通讯方式 Communication Method	CAN、PWM	

- 请在上电前确保此接插件与对接件正负极对应无误，接反会瞬间造成无法修复的损坏！请确保高低压对接件上的密封塞安装到位，如果未装密封塞会使水和水蒸汽进入驱动控制器，造成驱动控制器短路或烧毁。
- Please ensure that this connector corresponds correctly with the positive and negative terminals of the connector before power-on, as the reverse connection will cause irreparable damage instantly!
- Make sure that the sealing plug on the high and low pressure butt fittings is installed properly. If the sealing plug is not installed, water and water vapor will enter the drive controller, resulting in short circuit or burn of the drive controller.



2.4 接插件 Connector

*此处列举了可供客户常用选择的接插件型号。定制开发的接插件信息请与 BENLING 取得联系 TEL: 021-57483303。

*详细接插件其余性能及尺寸，请至 BENLING 官方网站 www.benling-sh.com 下载接插件规格书。

*接口定义具体见图纸

* Here is a list of common connector models available. Please contact BENLING at TEL: 021-57483303 for information on custom developed connectors.

* For details of other functions and dimensions of the connector, please download the connector specification from BENLING's official website www.benling-sh.com.

* See the drawing for pin definition

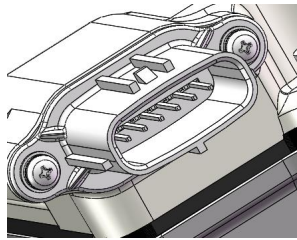
信号线 LV side	品牌 Brand			
	型号 Model	6PIN-鹤壁新纪元 6PIN-Hebi		
	针脚定义 Pin Definition	P1	CANL	
		P2	CANH	
		P3	负极 -	
		P4	PWM/互锁 2 PWM/HVIL2	
		P5	使能/互锁 1 Enable signal/HVIL1	
		P6	正极 +	
		N/A		
N/A				
图示 Diagram				

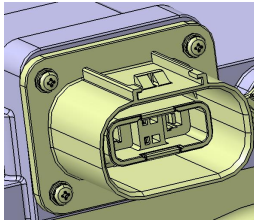
电源线 HV side	品牌 Brand	中航光电 JONHON		
	型号 Model	HVIL-F2P(40A)-A		
	针脚定义 Pin Definition	A	负极 -	
		B	正极 +	
图示 Diagram				

2.5 制冷性能 Cooling Capacity

工况描述 Working Condition description			性能表现 Performance			
			转速 (rpm) Speed	制冷量 (W) Cooling Capacity	输入功率 (W) Input Power	COP (W/W) COP
常用工况一 *来源 GB/T22068-2018 Common working condition 1 * Source GB/T22068-2018	蒸发温度 Evaporating Temp	7°C				
	冷凝温度 Condensing Temp	55°C	3000	8460	3290	2.57
	过热度 Superheat	10°C	4000	11650	4430	2.63
	过冷度 Supercooling	8°C	5000	14890	5660	2.63
	环境温度 Ambient temperature	50°C	6000	18000	6820	2.64
常用工况二 *汽车行业常用工况 Common working condition 2 *Common working conditions in automotive industry	蒸发温度 Evaporating Temp	0.672°C				
	冷凝温度 Condensation Temp	55.233°C	3000	6360	3100	2.05
	过热度 Superheat	10°C	4000	8760	4170	2.10
	过冷度 Supercooling	5°C	5000	11190	5330	2.10
	环境温度 Ambient temperature	室温 indoor temperature	6000	13500	6430	2.10



注:转速误差±1%, 实测制冷量不小于表中数值的93%, 实测功率不大于表中数值的110%.

Remark: Speed tolerance ±1%, actual test cooling capacity data not less than 93% of data in the table, actual test power rate not exceed 110% of data in the table

性能曲线 Performance Curve

工况一性能曲线
Working Condition 1

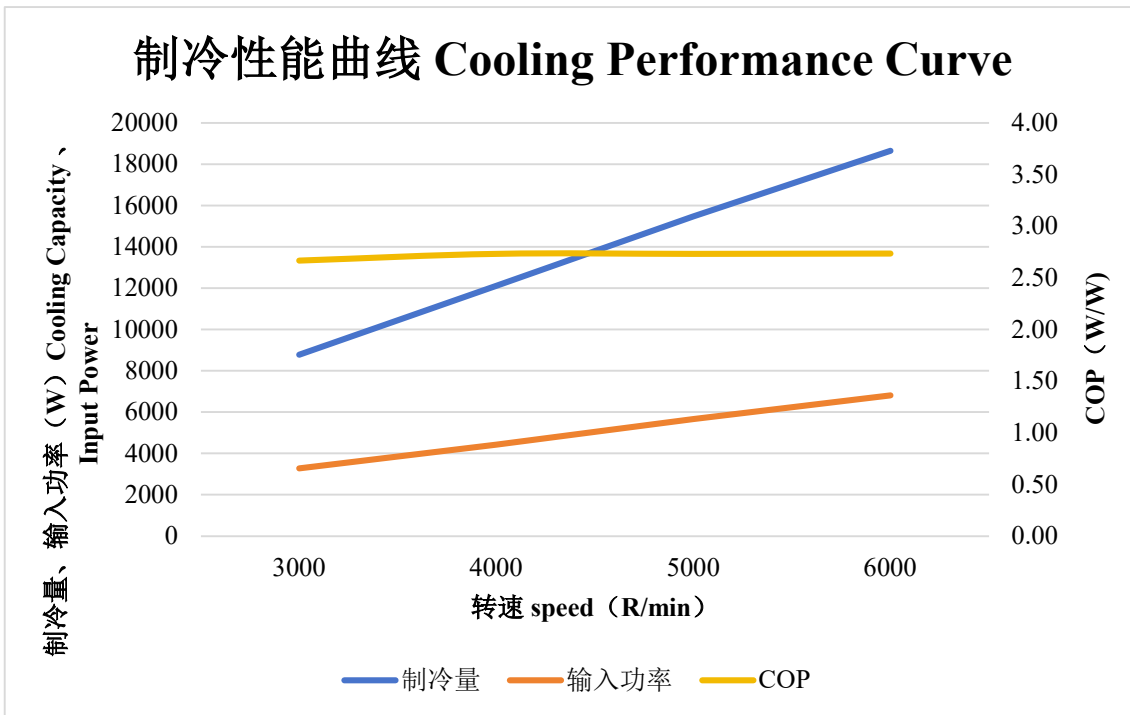

工况二性能曲线
Working Condition 2

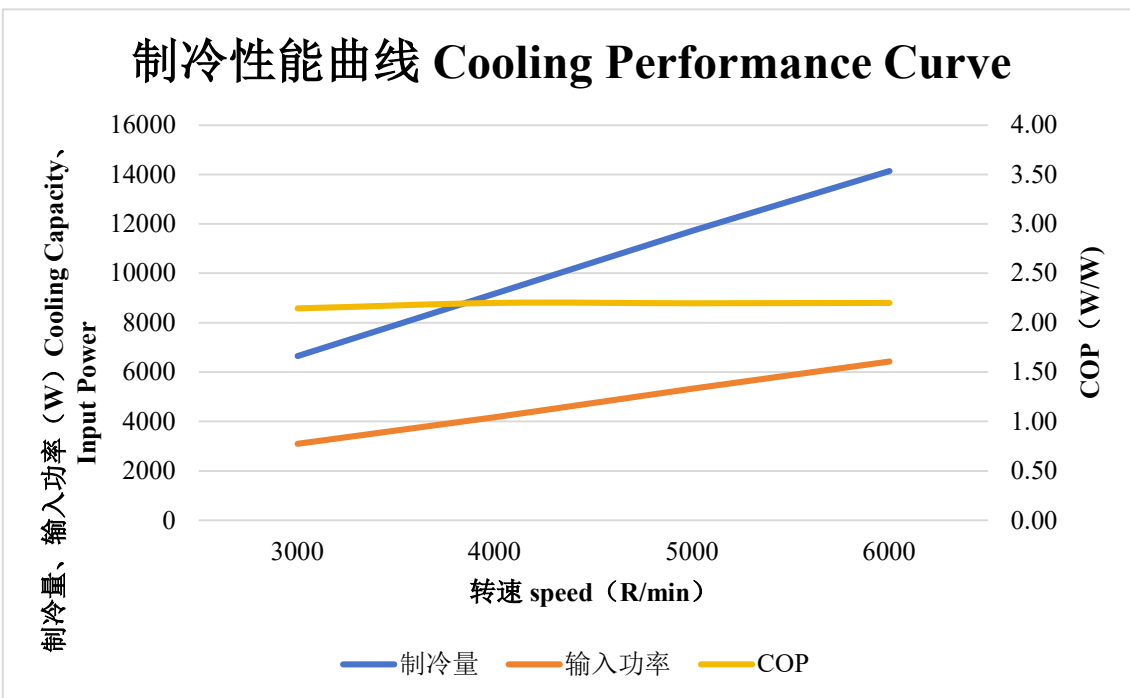

2.6 噪声 Noise

工况 Working condition	蒸发温度 Evaporating temperature	冷凝温度 Condensing temperature	过热度 Superheat	过冷度 Supercooling	环境温度 Ambient temperature
	0.672°C	55.233°C	10°C	5°C	室温 indoor temperature

转速 Speed (rpm)	5000
噪声 Noise level dB(A)	≤76



注:噪声传感器安装在压缩机几何中心正上方 100cm 及前、后、左、右方向各 100cm 处取 5 点平均值 Remark:
Noise sensor locate at 100cm above、front、behind、left、right compressor.

3. 使用要求 Requirement

3.1 系统建议 System recommendations

系统建议 High pressure protection (absolute pressure)	指标 Index
高压压力保护(绝压) High pressure protection (absolute pressure)	高于 2.8MPa 断开, 2.6MPa 恢复(取决于客户要求) Higher than 2.8MPa disconnect, 2.6MPa recovery (depending on customer requirements)
低压压力保护(绝压) Low pressure protection (absolute pressure)	低于 0.07MPa 断开, 恢复情况取决于吸气压力的上升速率建议采取一定的延时, 尽量避免噪音问题。(取决于客户要求) Will disconnect below 0.07MPa, and the recovery depends on the rise rate of suction pressure. It is recommended to take a certain time delay to avoid noise problems as much as possible. (subject to customer requirements)
最高吸气温度 Maximum suction temperature	< 30 °C (环境温度 120°C时) < 30 °C (ambient temperature 120°C)
冷冻油 Refrigerant Oil	800mL (取决于空调系统 OCR 的标定结果) 800mL (depending on OCR calibration result of air conditioning system)
系统制冷剂水分量 Water residue content	75PPM Max.
含尘量 Dust content	25mg Max
吸排气连接扭矩 Suction and exhaust connection torque	压缩机吸排气口的压紧螺栓扭矩为 11 ± 1 N · M The torque of the compression bolt of the suction and exhaust port of the compressor is 11 ± 1 N · M
启动温度 Starting temperature	-15°C < 环境温度 < 过温保护点, Pd < 20bar -15 °C < ambient temperature < overtemperature protection point, Pd < 20bar
OCR 要求 OCR Requirement	3000-6000rpm >2% , 6000-8000rpm >3%
排气温度上限 upper limit of discharge port	125°C

<p>压缩机连续运行的吸气干度 Suction dryness of the compressor in continuous operation</p>	<p>> 90%</p>
<p>其它 Others</p>	<p>压缩机需要制冷剂冷却电机和控制器,吸气管路应增加绝缘保温管。 Compressors need refrigerant to cool motors and controllers, Insulation pipes should be added to the suction pipes.</p>
	<p>建议压缩机启动 6 秒前,开启冷凝器风扇,压缩机停机后,冷凝风扇关断滞后 30 秒。 It is recommended that start the condenser fan six seconds before the compressor starts. After the compressor is shut down, the condensing fan should be turned off 30 seconds later.</p>
	<p>为避免系统进入过多水分导致绝缘下降,压缩机吸排气口打开后应立即(5 分钟内)装入封闭的系统中 In order to prevent the insulation from decreasing due to excessive moisture entering the system, the compressor suction and exhaust ports should be installed in the closed system immediately after opening (within 5 minutes)</p>
	<p>压缩机应安装减振脚垫以达到减振和降噪目的 The compressor should be installed with vibration absorbing pads to achieve vibration and noise reduction purposes</p>

3.2 压缩机推荐运行范围 Recommended working condition

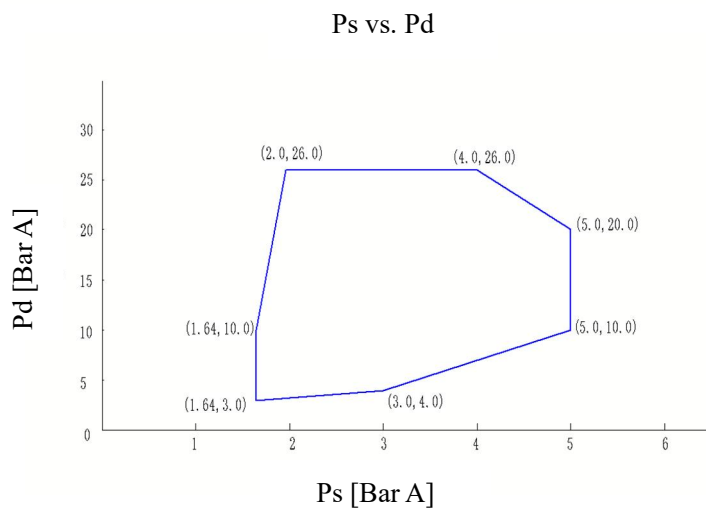
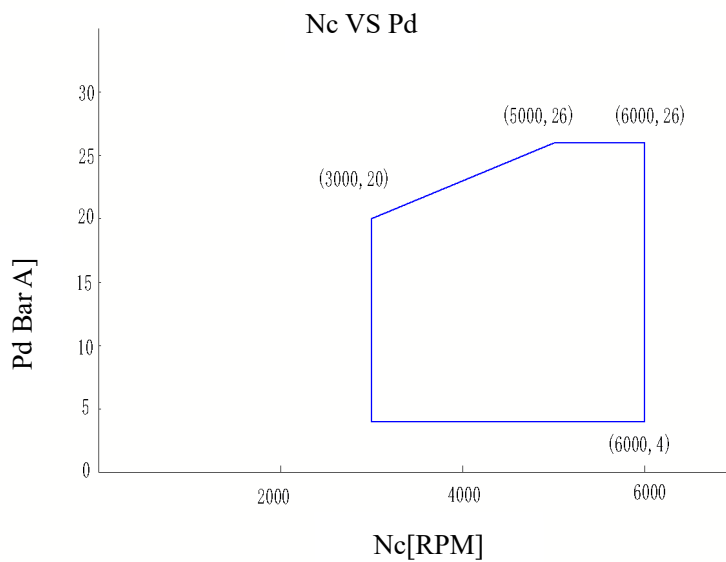
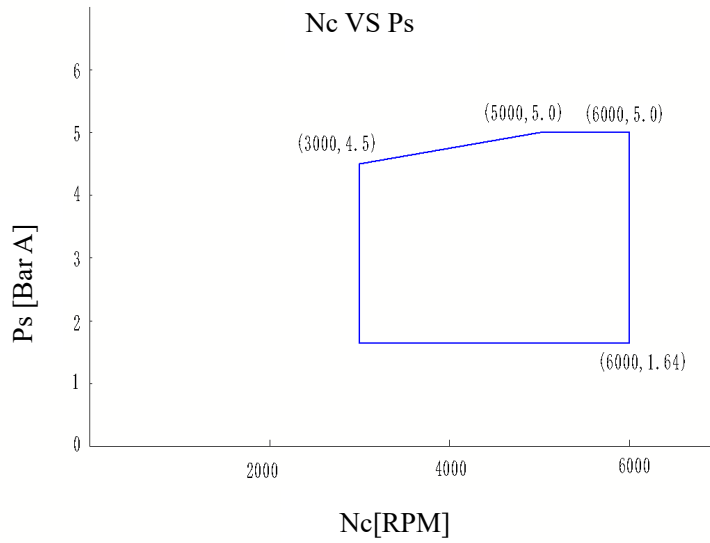

4. 附件 A Annex A

80 系列产品对比 80 series product comparison

固定式侧出连接器 Fixed side outlet connector	
	适用机型 a p p l i c a b l e m o d e l s
	DM80C3-XXXXX
	DM80A3-XXXXX